

USER'S MANUAL

6.25KSS6050/5060

3rd Edition

Frequency Converter

Visicomm Industries LLC
911A Milwaukee Ave.
Burlington, WI 53105

1. INTRODUCTION

The conversion of electrical power is an essential requirement for export testing or operation of equipment brought to the U.S. from abroad. The KSS series Frequency Converter is designed to meet these needs as it supplies reliable, pure and stable power at an affordable price.

This Converter is designed with the following unique features

- Double Conversion IGBT module, Single control board design, eliminates adjustment, and minimizes maintenance.
- LCD display for unit status, user friendly design
- Special overload capacity design, 150% overload for 30 sec.
- Built-in isolation transformer to ensure total isolation between the input and output.
- Special airflow control to avoid dust accumulation. Suitable for any rough operating environments.
- Compact size, light weight.

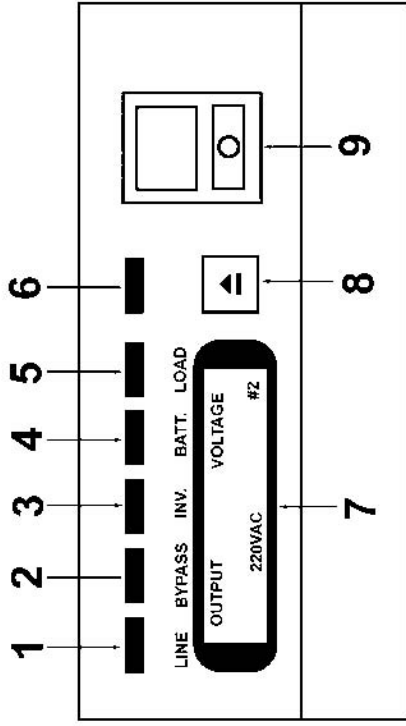

2.1 FRONT PANEL

1. LINE LED: This indicates the incoming AC line is normal.
3. INVERTER LED: This means the converter power is supplied from inverter.
6. FAULT LED: This indicates the converter is in fault condition.
7. LCD DISPLAY
 - (1) INPUT VOLTAGE
 - (2) OUTPUT VOLTAGE
 - (3) INPUT FREQUENCY
 - (4) OUTPUT FREQUENCY
 - (5) OUTPUT POWER
 - (6) NO OUTPUT
8. LCD Switch: Display items can be changed using the LCD switch.
9. PUSH ON-OFF SWITCH: This switch turns the converter on or off.
10. VENTILATION LOUVERS: Please keep the ventilation louvers clean.

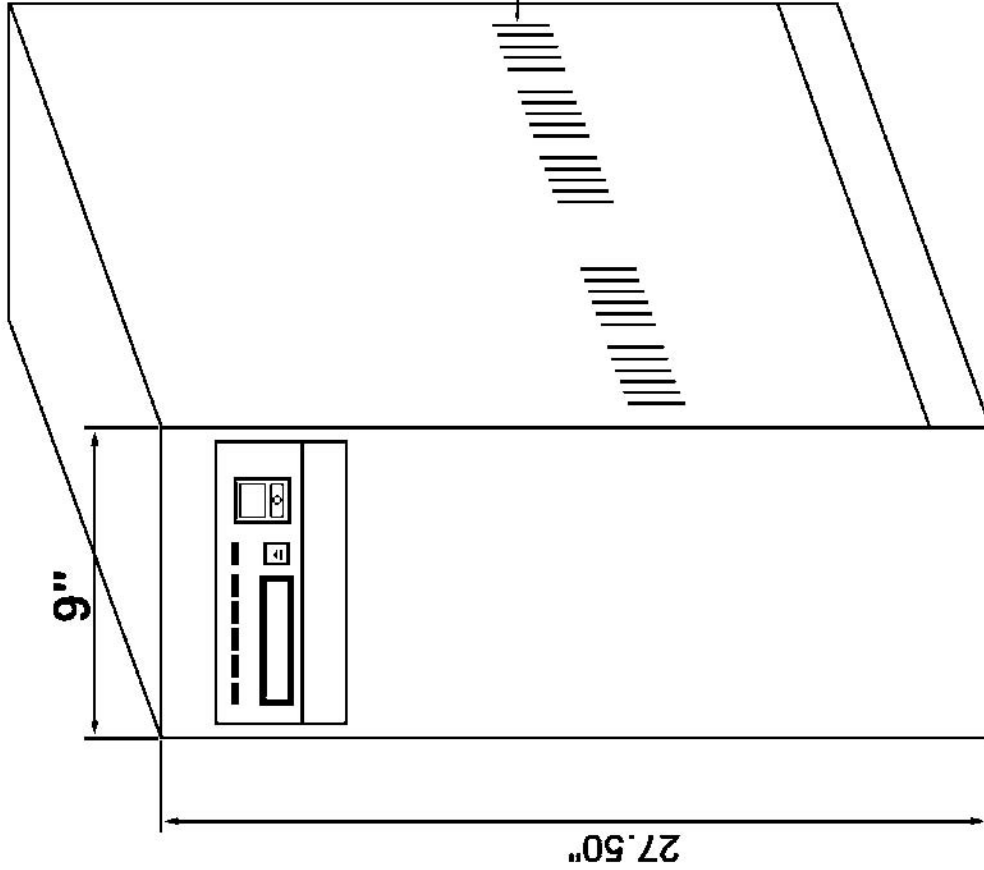

DEPTH = 22.88"

**6.25KSS6050/5060
FREQUENCY CONVERTER
(FRONT)**

2.2 REAR PANEL

11. LCD Display selector switch.
12. Frequency selector switch
13. Main Input breaker (SWA). Controls the AC Commercial input Power, in addition This breaker trips if the output power is subject to a Dead short.
14. Input terminal: The input power leads will be connected to the terminal block either 120VAC range or 220VAC range (See spec. sheet) output terminal: 120V L-N
15. output Voltage adjustment potentiometer
16. Ground terminal

CAUTION:

SINGLE PHASE 120V OUTPUT
CONNECT N TO THE SYSTEM
"NEUTRAL". L1 IS THE 120V
OUTPUT

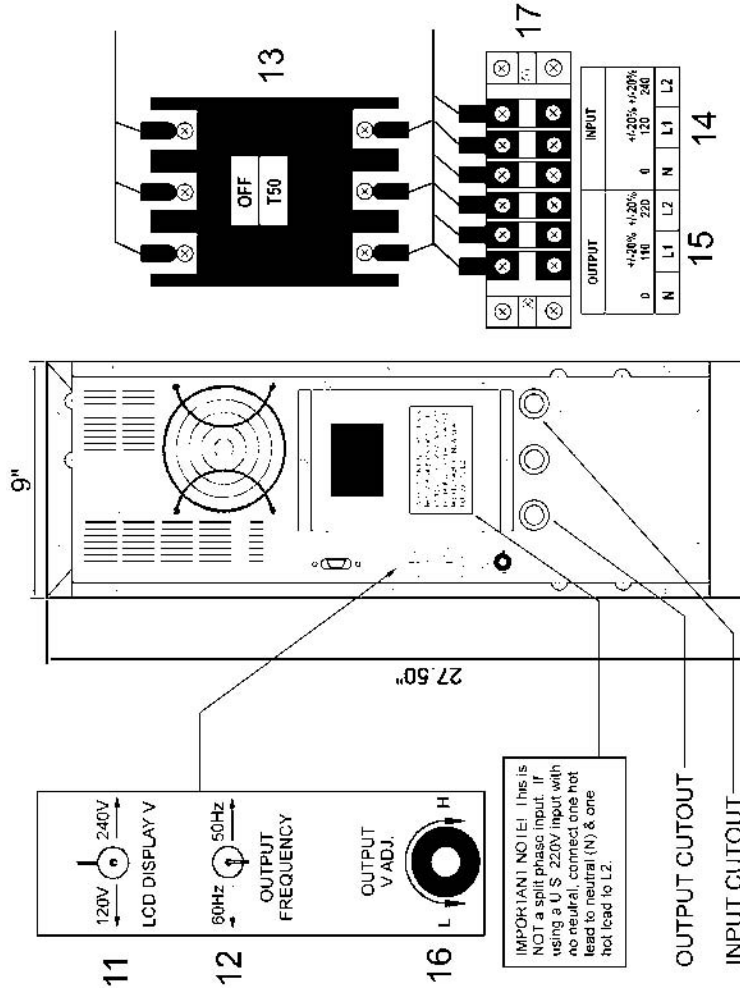

6.25KSS6050/5060 FREQUENCY CONVERTER (BACK)

Input Power Connections and Grounding

System Ground Connection:

The Earth Ground should be provided by the utility. This is normally the “GREEN” wire provided by the utility which at some point is routed to a secure earth ground such as a water pipe. This wire should be connected to the screw post marked GND on the Converter (See photo for location).

Note that there are no internal electrical connections to this wire with the exception of a small high frequency bypass capacitor for RF suppression. Therefore, the function of the Earth Ground is simply to maintain the case of the Converter at ground potential. Visicomm Industries (LLC) does not recommend any other connection to the Earth Ground wire which may introduce significant amounts of current and thereby defeat the intended purpose of this wire which is the safety of the operating personnel. In particular, do not connect this wire to the system neutral wire at any point.

Output Connection:

The Power OUTPUT Connections are provided by three barrier terminal posts labeled N, L1, and L2. These three terminals constitute the three terminals of an internal auto-transformer where L1 is the “center tap”. This is fed by the output winding of a switching transformer. Since the only other internal connections are a resonating capacitor, the cooling fans, and sensing circuits(to maintain an output sine wave), these output terminals are electrically isolated from any other circuits including the system neutral.

The Converter is shipped with these OUTPUT connections electrically isolated. If a digital voltmeter is connected between any one of these OUTPUT terminals and the Earth Ground, a significant voltage reading will be obtained. This voltage is due to a small leakage current and is not considered a problem since only 1 or 2 ma is involved.

Output Isolation:

Many applications require an **isolated output**, primarily for safety reasons, when supplying power to a device under test especially if there will be other monitoring equipment connected to the device. Other applications can take advantage of the low leakage current of the Converter (about 1 or 2 ma). This can be useful in systems where the individual leakage currents of the components might exceed the allowed leakage current of a ground fault interrupter.

Other applications require that the **output have a connection to the utility NEUTRAL**. Normally this would be OUTPUT terminal N (The exception would be a two phase output where L1 would be the connection to the system NEUTRAL). The Converter is supplied with a short jumper wire. If the system NEUTRAL is used to power the INPUT terminals and it is required that the OUTPUT be connected to NEUTRAL this jumper can be employed to make this connection.

If the INPUT is supplied by two phase AC or by two phases of a three phase system (in other words, if you have only two incoming power wires), this NEUTRAL would not be present and an external wire from the desired OUTPUT terminal to the system NEUTRAL would be required. See INPUT CONNECTION DIAGRAM on next page.

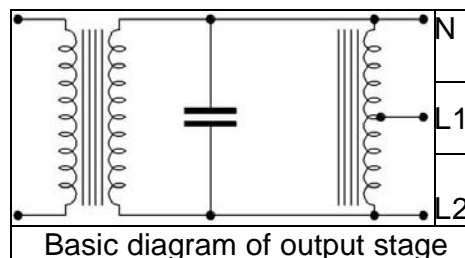

INPUT POWER CONNECTIONS

The frequency of the input power can be 50 or 60 Hz, and is not related to the output frequency

CAUTION:

The Input is Electrically Isolated from the output.
It is necessary to connect the input using one of the following four methods.

A. SINGLE PHASE 220V INPUT

This connection is usually used in 50Hz countries where a neutral is normally available.

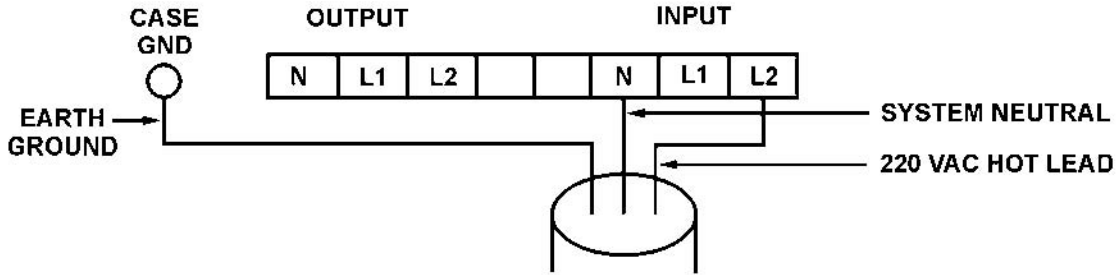

B. SPLIT PHASE 220V INPUT

This connection is usually used in 60Hz countries where a 220V line is not normally available, and where the input amperage makes using 120V inconvenient.

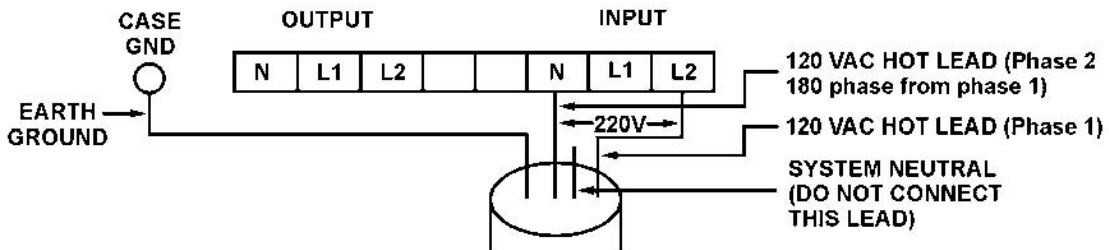

C. SINGLE PHASE 120V INPUT

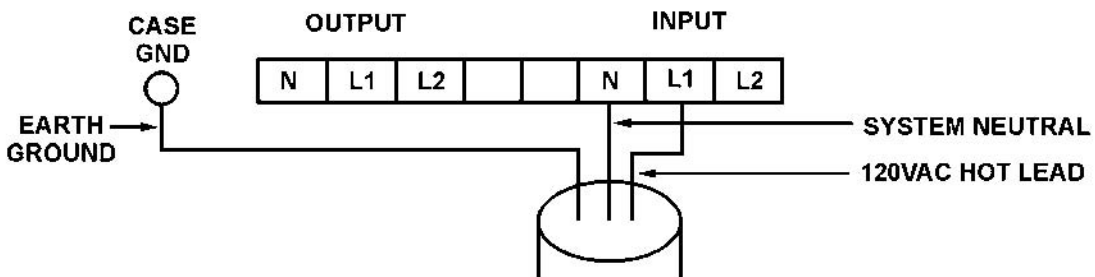

D. THREE PHASE 120/208 VAC USING LINE TO LINE INPUT

To be used if the 120V line to neutral connection is limited by the amperage available.

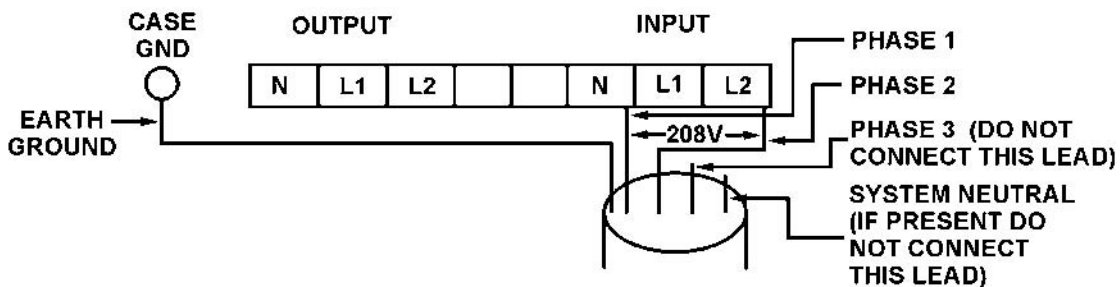

OUTPUT POWER CONNECTIONS

The frequency of the output power can be 50 or 60 Hz, and is not related to the input frequency

CAUTION:

The output is "floating" and is electrically isolated from the input.
It is necessary to connect the output using one of the following three methods.
Note that these output voltages are widely adjustable using the voltage adjust rheostat.

A. SINGLE PHASE 120V OUTPUT

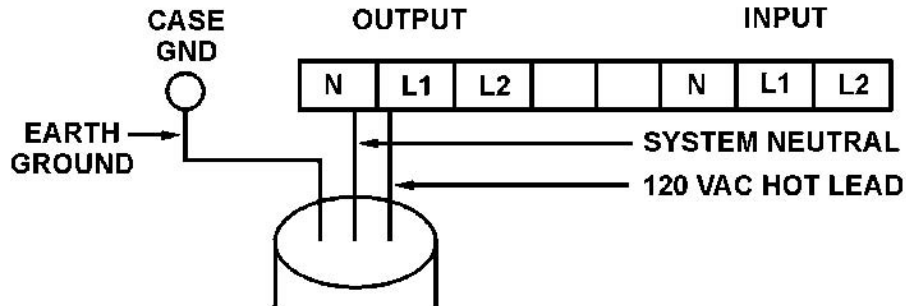

B. SINGLE PHASE 220V OUTPUT

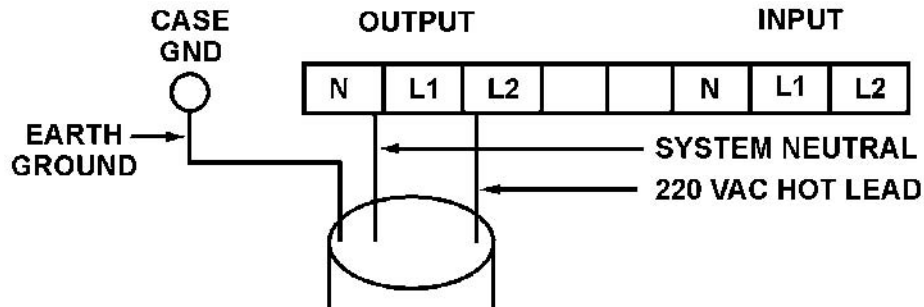

C. SPLIT PHASE 220V OUTPUT

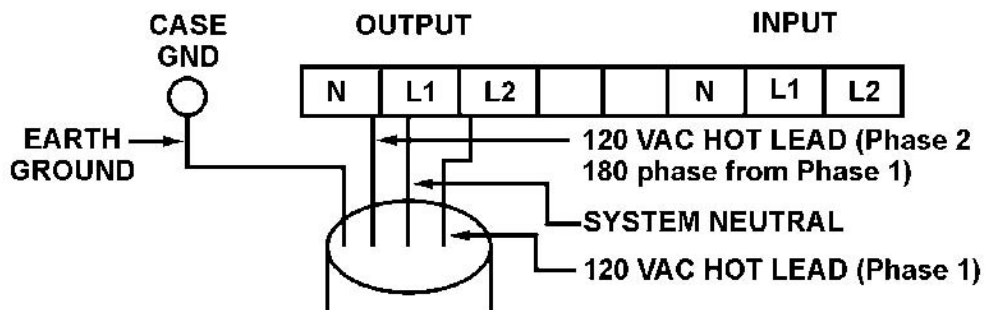

4. SPECIFICATION

| | | |
|--|--------------------------------|---|
| Model | 6.25KSS6050/5060 | |
| Capacity | 6.25KVA /5kW | |
| Input | Voltage | 120 or 220VAC |
| | Voltage Range | 120V -15%/+20% or 220V -15%/+20% |
| | Frequency | 50 Hz or 60 Hz \pm 5% |
| | Phase | Single |
| Output | Voltage | 120 or 220VAC \pm 20% |
| | Voltage Regulation | \pm 1 % |
| | Frequency | 50 Hz or 60 Hz (400Hz available) |
| | Frequency Regulation | \pm 0.0004% (xtal oscillator) |
| | Harmonic Distortion | < 3% at 100% Linear Load |
| | Output Waveform | Pure Sinewave |
| Efficiency | AC to AC | > 85% |
| Output Current | Normal | @ 120V-50A, @ 220V-28A |
| | Overload @ 150% for 30 seconds | 75A @ 120V/42A @ 220V |
| Power Factor | 0.8 | |
| Crest Ratio | 3:1 | |
| Indicator- Detachable & Remote Control | LCD | Automatically configures to monitor voltage, frequency, and loading, simultaneously |
| | LED | Line: Green LED Fault: Red LED Inverter: Green LED Overload: Yellow LED |
| Audible Alarm | Overload | Sounds continuously |
| | Converter Fault | Sounds continuously |
| Protection | Overload | 150% Delay 30 Seconds, current limited |
| | Short Circuit | Unit will cut out and must be manually restarted |
| | EMI Filter | 10-100KHz at 40dB, 100KHz-100MHz at 70dB |
| | Over Temperature | Inverter auto cut-off when heat sink temp. over 80°C. |
| Environment | Operation Temp. | -10°C to 50°C; 14°F to 122°F |
| | Relative Humidity | 20-90% non-condensing |
| | Audible Noise | <45dB |
| Physical Dimensions | Net Weight | 188lbs |
| | Depth x Width x Height | 22.88in x 9.0in x 27.50in |